

# **Moxa Optical Fiber Bypass Unit**

---

## **OBU-102 Series Hardware Installation Guide**

**Second Edition, April 2014**



© 2014 Moxa Inc. All rights reserved.

**P/N: 1802001020011**

## Overview

The OBU-102 series is an industrial optical fiber bypass unit installed to protect a 100M/1G/10G fiber optical network from large-scale failure resulted during power outage or network maintenance. The bypass unit has 2 inline ports that are used to connect to the local Ethernet switch, and 2 network ports that are used to connect to the other 2 remote Ethernet switches in the main network. When the bypass unit receives power, it will forward network traffic to the local switch. When the bypass unit loses power, it will bypass the local switch and send traffic between 2 remote switches. The bypass unit is expected to be powered from the same power source with the local switch to ensure power loss makes the bypass unit change to bypass mode.

## Package Checklist

Your package is shipped with the following items. If any of these items is missing or damaged, please contact your customer service representative for assistance.

- Moxa Optical Fiber Bypass Unit
- Hardware Installation Guide
- Moxa Product Warranty booklet

## Features

- Supports 100M/1G/10Gbps single-mode optical fiber with SC/ST/LC connectors
- Optical bypass switching time < 10 ms
- Low insertion loss
- Redundant dual power 12/24/48 VDC
- Operating temperature range from -20 to 70°C
- IP30 metal housing
- DIN-rail or panel mounting ability
- Configurable boot delay range from 0 to 45 seconds by rotary switch

# Panel Layout of OBU-102

## OBU-102-SS-SC

Front Panel View

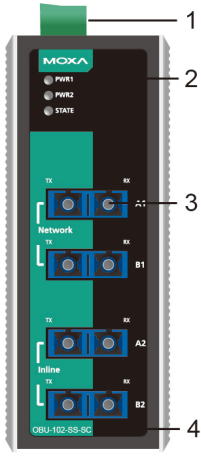

- 1. Terminal block for power input PWR1/PWR2
- 2. LEDs for power inputs and bypass state
- 3. 100M/1G/10Gbps fiber ports
- 4. Model name
- 5. Grounding screw
- 6. Rotary switch for boot delay
- 7. Screw holes for wall mounting kit
- 8. DIN-rail kit

Top Panel View

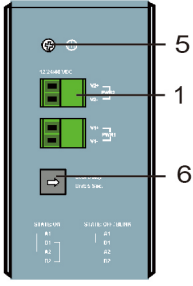

Rear Panel View

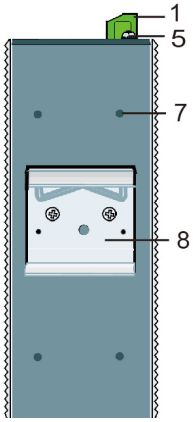

# OBU-102-SS-ST

## Front Panel View

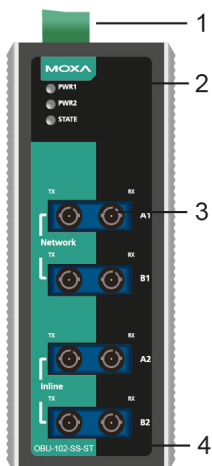

1. Terminal block for power input PWR1/PWR2
2. LEDs for power inputs and bypass state
3. 100M/1G/10Gbps fiber ports
4. Model name
5. Grounding screw
6. Rotary switch for boot delay
7. Screw holes for wall mounting kit
8. DIN-rail kit

## Top Panel View

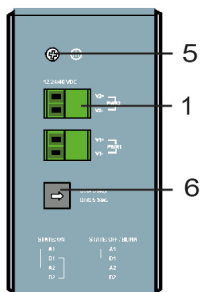

## Rear Panel View

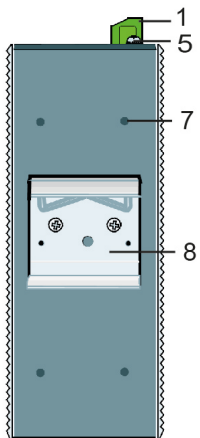

# OBU-102-SS-LC

## Front Panel View

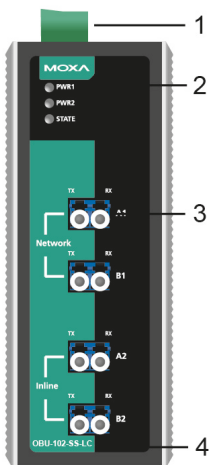

1. Terminal block for power input PWR1/PWR2
2. LEDs for power inputs and bypass state
3. 100M/1G/10Gbps fiber ports
4. Model name
5. Grounding screw
6. Rotary switch for boot delay
7. Screw holes for wall mounting kit
8. DIN-rail kit

## Top Panel View

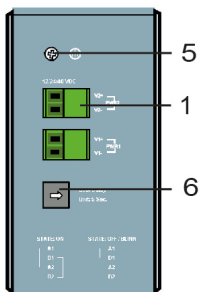

## Rear Panel View

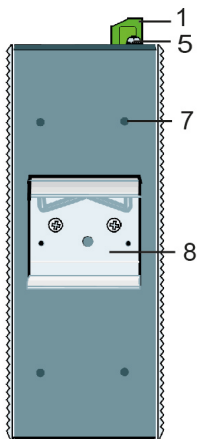

# Mounting Dimensions

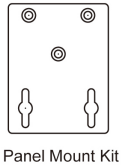
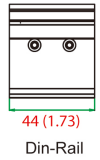
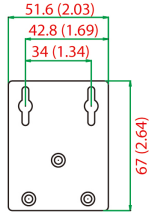
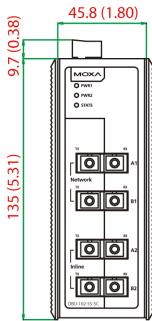
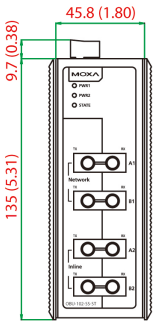
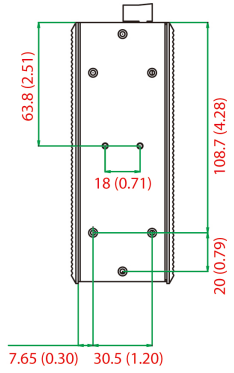
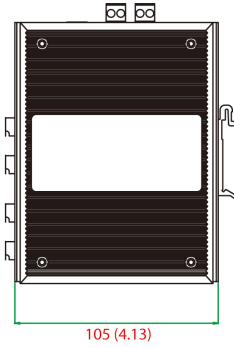
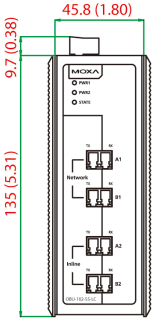

Unit = mm (inch)

## DIN-Rail Mounting

The aluminum DIN-rail attachment plate should already be fixed to the back panel when you take it out of the box. If you need to reattach the DIN-rail attachment plate, make sure the stiff metal spring is situated towards the top, as shown in the figures below.

**STEP 1:** Insert the top of the DIN-Rail into the slot just below the stiff metal spring.

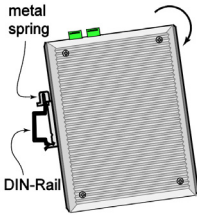

**STEP 2:** The DIN-Rail attachment unit will snap into place as shown below.

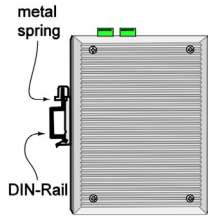

To remove the OBU from the DIN-Rail, simply reverse Steps 1 and 2 above.

## Wall Mounting (optional)

For some applications, you will find it convenient to mount the OBU-102 on the wall, as shown in the following figures.

**STEP 1:** Remove the aluminum DIN-Rail attachment plate from the OBU-102's rear panel, and then attach the wall mount plates as shown in the diagram at the right.

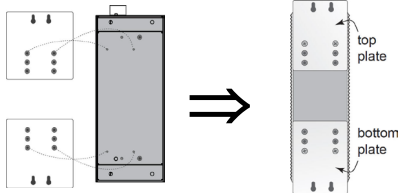

**STEP 2:** Mounting the OBU-102 on the wall requires 4 screws. Use the switch, with wall mount plates attached, as a guide to mark the correct locations of the 4 screws. The heads of the screws should be less than 6.0 mm in diameter, and the shafts should be less than 3.5 mm in diameter, as shown in the figure at the right.

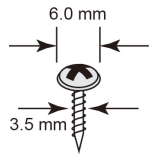

**NOTE** Before tightening the screws into the wall, make sure the screw head and shank size are suitable by inserting the screw into one of the keyhole-shaped apertures of the wall mounting plates.

Do not screw the screws in completely—leave about 2 mm to allow room for sliding the wall mount panel between the wall and the screws.

### STEP 3:

Once the screws are fixed on the wall, insert the four screw heads through the large parts of the keyhole-shaped apertures, and then slide the OBU-102 downwards, as indicated. Tighten the four screws for added stability.

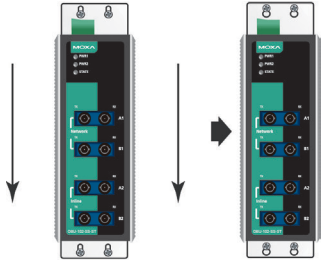

## Wiring Requirements



### WARNING

#### Safety First!

Turn the power off before disconnecting modules or wires. The correct power supply voltage is listed on the product label. Check the voltage of your power source to make sure that you are using the correct voltage. Do **NOT** use a voltage greater than what is specified on the product label.

These devices must be supplied by a SELV source as defined in the Low Voltage Directive 2006/95/EC and 2004/108/EC.



### WARNING

#### Safety First!

Calculate the maximum possible current in each power wire and common wire. Observe all electrical codes dictating the maximum current allowable for each wire size.

If the current goes above the maximum ratings, the wiring could overheat, causing serious damage to your equipment.

You should also pay attention to the following points:

- Use separate paths to route wiring for power and devices. If power wiring and device wiring paths must cross, make sure the wires are perpendicular at the intersection point.  
NOTE: Do not run signal or communications wiring and power wiring in the same wire conduit. To avoid interference, wires with different signal characteristics should be routed separately.
- You can use the type of signal transmitted through a wire to determine which wires should be kept separate. The rule of thumb is that wiring that shares similar electrical characteristics can be bundled together.
- Keep input wiring and output wiring separated.
- It is strongly advised that you label wiring to all devices in the system when necessary.



## Grounding the Device

Grounding and wire routing help limit the effects of noise due to electromagnetic interference (EMI). Run the ground connection from the ground screw to the grounding surface prior to connecting devices.



### ATTENTION

This product is intended to be mounted to a well-grounded mounting surface such as a metal panel.

## Wiring the Redundant Power Inputs

The top two contacts and the bottom two contacts of the 2-contact terminal block connector on the top panel are used for the two DC inputs. Top and front views of one of the terminal block connectors are shown here.



Top View



Front View

#### STEP 1:

Insert the negative/positive DC wires into the V-/V+ terminals.

#### STEP 2:

To keep the DC wires from pulling loose, use a small flat-blade screwdriver to tighten the wire-clamp screws on the front of the terminal block connector.

#### STEP 3:

Insert the plastic terminal block connector prongs into the terminal block receptor, which is located on top panel.



### ATTENTION

Before connecting the OBU-102 to the DC power inputs, make sure the DC power source voltage is stable.

# Communication Connections

The OBU-102 models have 2 inline fiber ports that are used to connect to the local Ethernet switch, and 2 network fiber ports that are used to connect to the other 2 remote Ethernet switches in the main network.

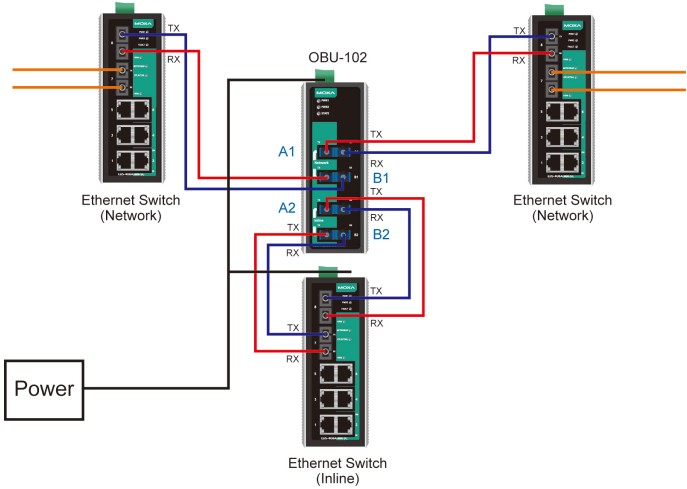

Mode	Normal Mode	Bypass Mode
Conditions	Power on	1. Power off 2. Or in delay after power is restored
State LED	On	Off/Blinking
OBU-102's actions	OBU-102 forwards packets between network switches and the inline switch	OBU-102 bypasses the inline switch and directly forwards packets between network switches.
Packet Transmission Paths		

## Redundant Power Inputs

Both power inputs can be connected simultaneously to live DC power sources. If one power source fails, the other live source acts as a backup, and automatically supplies all of power needs.

## Rotary Switch Settings

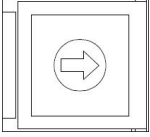

When power is restored to a bypass unit and its associated Ethernet switch, there is still a potential network failure. This is because Ethernet switches typically need several seconds to boot up, while the bypass unit will boot up in just a few milliseconds.

Thus, the Ethernet switch will still be booting up when the bypass unit begins sending packets to process. The OBU-102 has a rotary switch that can be used to specify a period of time to delay sending new packets after power is restored, to ensure that the Ethernet switch will be fully active and ready to receive packets at the time that the OBU-102 begins sending them. The rotary switch has 10 steps, marked from 0 to 9. Each step represents a 5 second delay, so the user can set a delay of 0 to 45 seconds using the rotary switch, depending on the boot time of the connected Ethernet switch.

## LED Indicators

The front panel contains several LED indicators. The function of each LED is described in the table below.

LED	Color	State	Description
<b>PWR1</b>	AMBER	On	Power is being supplied to power input P1.
		Off	Power is <b>not</b> being supplied to power input P1.
<b>PWR2</b>	AMBER	On	Power is being supplied to power input P2.
		Off	Power is <b>not</b> being supplied to power input P2.
<b>State</b>	Green	On	Traffic forwarded to the inline Ethernet switch (A1-A2, B1-B2)
		Blinking	Bypass the inline Ethernet switch. In boot delay. (A1-B1)
		Off	Bypass the inline Ethernet switch. (A1-B1)

## Specifications

<b>Interface</b>	
Fiber Ports	SC/ST/LC connector, single-mode
LED Indicators	P1, P2 (Power), State (bypass state)
Rotary Switch	Configure delay after boot up, from 0 to 45 seconds
<b>Power</b>	
Input Voltage	12/24/48 VDC (9.6 to 60 VDC),
Input Current @ 24VDC	0.03
Connection	Removable 2-contact terminal block
Overload Current Protection	1.1 A
Reverse Polarity Protection	Present
<b>Physical Characteristics</b>	
Housing	IP30 protection, metal case
Dimensions	53.6 x 135 x 105 mm (2.11 x 5.31 x 4.13 in)
Weight	700 g
Installation	DIN-Rail Mounting, Wall Mounting (with optional kit)
<b>Environmental Limits</b>	
Operating Temperature	-20 to 70°C (-4 to 158°F)
Storage Temperature	-40 to 85°C (-40 to 185°F)
Ambient Relative Humidity	5 to 95% (non-condensing)
<b>Regulatory Approvals</b>	
Safety	UL508
EMI	FCC Part 15, CISPR (EN55022) class A
EMS	EN61000-4-2 (ESD), Level 3 EN61000-4-3 (RS), Level 3 EN61000-4-4 (EFT), Level 3 EN61000-4-5 (Surge), Level 3 EN61000-4-6 (CS), Level 3 EN61000-4-8 EN61000-4-11
Shock	IEC 60068-2-27
Freefall	IEC 60068-2-32
Vibration	IEC 60068-2-6
<b>WARRANTY</b>	2 years

### Technical Support Contact Information [www.moxa.com/support](http://www.moxa.com/support)

#### Moxa Americas:

Toll-free: 1-888-669-2872

Tel: 1-714-528-6777

Fax: 1-714-528-6778

#### Moxa China (Shanghai office):

Toll-free: 800-820-5036

Tel: +86-21-5258-9955

Fax: +86-21-5258-5505

#### Moxa Europe:

Tel: +49-89-3 70 03 99-0

Fax: +49-89-3 70 03 99-99

#### Moxa Asia-Pacific:

Tel: +886-2-8919-1230

Fax: +886-2-8919-1231