

# DrayTek

## Vigor2927 Series

Dual-WAN Security Router



QUICK START GUIDE (WIRED MODEL)

V1.2

# Vigor2927

## Dual-WAN Security Router

### Quick Start Guide

#### (for Wired Model)

Version: 1.2

Firmware Version: V4.2.0.2

(For future update, please visit [DrayTek web site](http://www.draytek.com))

Date: December 02, 2020

## Intellectual Property Rights (IPR) Information

|                   |  |
|-------------------|--|
| <b>Copyrights</b> | © All rights reserved. This publication contains information that is protected by copyright. No part may be reproduced, transmitted, transcribed, stored in a retrieval system, or translated into any language without written permission from the copyright holders.   |
| <b>Trademarks</b> | The following trademarks are used in this document: <ul style="list-style-type: none"><li>● Microsoft is a registered trademark of Microsoft Corp.</li><li>● Windows, Windows 95, 98, Me, NT, 2000, XP, Vista, 7, 8, 10 and Explorer are trademarks of Microsoft Corp.</li><li>● Apple and Mac OS are registered trademarks of Apple Inc.</li><li>● Other products may be trademarks or registered trademarks of their respective manufacturers.</li></ul> |

## Safety Instructions and Approval

|                            |  |
|----------------------------|--|
| <b>Safety Instructions</b> | <ul style="list-style-type: none"><li>● Read the installation guide thoroughly before you set up the router.</li><li>● The router is a complicated electronic unit that may be repaired only by authorized and qualified personnel. Do not try to open or repair the router yourself.</li><li>● Do not place the router in a damp or humid place, e.g. a bathroom.</li><li>● Do not stack the routers.</li><li>● The router should be used in a sheltered area, within a temperature range of +5 to +40 Celsius.</li><li>● Do not expose the router to direct sunlight or other heat sources. The housing and electronic components may be damaged by direct sunlight or heat sources.</li><li>● Do not deploy the cable for LAN connection outdoor to prevent electronic shock hazards.</li><li>● Keep the package out of reach of children.</li><li>● When you want to dispose of the router, please follow local regulations on conservation of the environment.</li></ul>  |
| <b>Warranty</b>            | We warrant to the original end user (purchaser) that the router will be free from any defects in workmanship or materials for a period of two (2) years from the date of purchase from the dealer. Please keep your purchase receipt in a safe place as it serves as proof of date of purchase. During the warranty period, and upon proof of purchase, should the product have indications of failure due to faulty workmanship and/or materials, we will, at our discretion, repair or replace the defective products or components, without charge for either parts or labor, to whatever extent we deem necessary to restore the product to proper operating condition. Any replacement will consist of a new or re-manufactured functionally equivalent product of equal value, and will be offered solely at our discretion. This warranty will not apply if the product is modified, misused, tampered with, damaged by an act of God, or subjected to abnormal working conditions. The warranty does not cover the bundled or licensed software of other vendors. Defects which do not significantly affect the usability of the product will not be covered by the warranty. We reserve the right to revise the manual and online documentation and to make changes from time to time in the contents hereof without obligation to notify any person of such revision or changes. |



## EU Declaration of Conformity

We DrayTek Corp. , office at No.26, Fu Shing Road, HuKou County, Hsin-Chu Industry Park, Hsinchu 300, Taiwan , R.O.C., declare under our sole responsibility that the product

- **Product name:** Dual-WAN Security Router
- **Model number:** Vigor2927
- **Manufacturer:** DrayTek Corp.
- **Address:** No.26, Fu Shing Road, HuKou County, Hsin-Chu Industry Park, Hsinchu 300, Taiwan , R.O.C.

is in conformity with the relevant Union harmonisation legislation:

EMC Directive 2014/30/EU , Low Voltage Directive 2014/35/EU , ErP 2009/125/EC and RoHS 2011/65/EU with reference to the following standards

| Standard         | Version / Issue date |
|------------------|----------------------|
| EN 55032         | 2012+AC:2013 class B |
| EN 61000-3-2     | 2014 Class A         |
| EN 61000-3-3     | 2013                 |
| EN 55024         | 2010+A1:2015         |
| EN 62368-1       | 2014+A11:2017        |
| EC No. 1275/2008 | 2008                 |

Hsinchu

(place)

2nd January, 2020

(date)



Calvin Ma / President .

(Legal Signature)



# Regulatory Information

## Federal Communication Commission Interference Statement

This equipment has been tested and found to comply with the limits for a Class B digital device, pursuant to Part 15 of the FCC Rules. These limits are designed to provide reasonable protection against harmful interference in a residential installation. This equipment generates, uses and can radiate radio frequency energy and, if not installed and used in accordance with the instructions, may cause harmful interference to radio communications. However, there is no guarantee that interference will not occur in a particular installation. If this equipment does cause harmful interference to radio or television reception, which can be determined by turning the equipment off and on, the user is encouraged to try to correct the interference by one of the following measures:

- Reorient or relocate the receiving antenna.
- Increase the separation between the equipment and receiver.
- Connect the equipment into an outlet on a circuit different from that to which the receiver is connected.
- Consult the dealer or an experienced radio/TV technician for help.

This device complies with Part 15 of the FCC Rules. Operation is subject to the following two conditions:

- (1) This device may not cause harmful interference, and
- (2) This device may accept any interference received, including interference that may cause undesired operation.

|                          |                |  |        |                     |
|--------------------------|----------------|--|--------|---------------------|
| USA Local Representative | Company name   | ABP International Inc.                         |        |                     |
|                          | Address        | 13988 Diplomat Drive Suite 180 Dallas TX 75234 |        |                     |
|                          | ZIP Code       | 75234  | E-mail | rmesser@abptech.com |
|                          | Contact Person | Mr. Robert Messer                              | Tel.   | 19728311600         |

### Caution:

Any changes or modifications not expressly approved by the grantee of this device could void the user's authority to operate the equipment.

Any changes or modifications not expressly approved by the party responsible for compliance could void the user's authority to operate this equipment.

\*The external power supply used for each product will be model dependent.

|                              | 1   | 2   | 3   | 4   | 5   | 6  | 7  | 8  | 9  |
|------------------------------|---|---|---|---|---|--|--|--|--|
| A Manufacturer               | CWT   | CWT   | CWT   | CWT   | CWT   | APD  | APD  | APD  | APD  |
| B Address                    | No. 222, Sec. 2, Nankan Rd., Lujhu Township, Taoyuan County 338, Taiwan | No. 222, Sec. 2, Nankan Rd., Lujhu Township, Taoyuan County 338, Taiwan | No. 222, Sec. 2, Nankan Rd., Lujhu Township, Taoyuan County 338, Taiwan | No. 222, Sec. 2, Nankan Rd., Lujhu Township, Taoyuan County 338, Taiwan | No. 222, Sec. 2, Nankan Rd., Lujhu Township, Taoyuan County 338, Taiwan | No. 5, Lane 83, Lung-Sou St., Taoyuan City 330, Taiwan | No. 5, Lane 83, Lung-Sou St., Taoyuan City 330, Taiwan | No. 5, Lane 83, Lung-Sou St., Taoyuan City 330, Taiwan | No. 5, Lane 83, Lung-Sou St., Taoyuan City 330, Taiwan |
| C Model identifier           | 2ABB012F UK<br>2ABB012F EU  | 2ABB018F UK<br>2ABB018F EU  | 2ABL024F UK<br>2ABL024F EU  | 2ABL030F UK<br>2ABL030F EU  | 2ABN036F UK<br>2ABN036F EU  | WA-12M12FG<br>WA-12M12FK                               | WB-18D12FG<br>WB-18D12FK                               | WA-24Q12FG<br>WA-24Q12FK                               | WA-36A12FG<br>WA-36A12FK                               |
| D Input voltage              | 100-240V  | 100-240V  | 100-240V  | 100-240V  | 100-240V  | 100-240V   | 100-240V   | 100-240V   | 100-240V   |
| E Input AC frequency         | 50/60Hz   | 50/60Hz   | 50/60Hz   | 50/60Hz   | 50/60Hz   | 50/60Hz  | 50/60Hz  | 50/60Hz  | 50/60Hz  |
| Output voltage DC            | 12.0V   | 12.0V   | 12.0V   | 12.0V   | 12.0V   | 12.0V  | 12.0V  | 12.0V  | 12.0V  |
| F Output current             | 1.0A  | 1.5A  | 2.0A  | 2.5A  | 3.0A  | 1.0A   | 1.5A   | 2.0A   | 3.0A   |
| G Output power               | 12.0W   | 18.0W   | 24.0W   | 30.0W   | 36.0W   | 12.0W  | 18.0W  | 24.0W  | 36.0W  |
| H Average active efficiency  | 84.9%   | 86.2%   | 87.6%   | 87.8%   | 89.8%   | 83.7%  | 85.4%  | 88.6%  | 88.2%  |
| I Efficiency at low load 10% | 73.6%   | 78.0%   | 81.3%   | 83.3%   | 83.7%   | 74.5%  | 80.5%  | 86.4%  | 85.4%  |
| J No-load power consumption  | 0.07W   | 0.07W   | 0.07W   | 0.07W   | 0.07W   | 0.07W  | 0.10W  | 0.07W  | 0.10W  |

External power supply (Power Adapter) information. For more update, please visit [www.draytek.com](http://www.draytek.com).



## ***Table of Contents***

|  |           |
|--|-----------|
| <b>1. Package Content .....</b>        | <b>1</b>  |
| <b>2. Panel Explanation.....</b>       | <b>2</b>  |
| 2.1 Vigor2927 .....                    | 2         |
| <b>3. Hardware Installation .....</b>  | <b>4</b>  |
| 3.1 Network Connection .....           | 4         |
| 3.2 Wall-Mounted Installation .....    | 5         |
| <b>4. Software Configuration .....</b> | <b>6</b>  |
| <b>5. Customer Service .....</b>       | <b>13</b> |
| Be a Registered Owner .....            | 13        |
| Firmware & Tools Updates .....         | 13        |

# 1. Package Content

Take a look at the package content. If there is anything missed or damaged, please contact DrayTek or dealer immediately. Besides, the content is subject to the real package.



**Vigor Router**

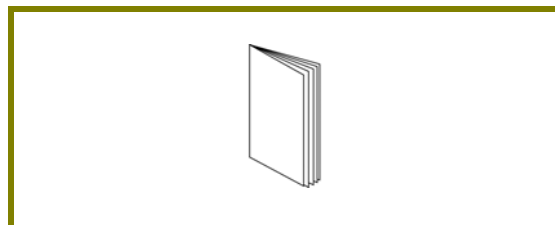

**Quick Start Guide**

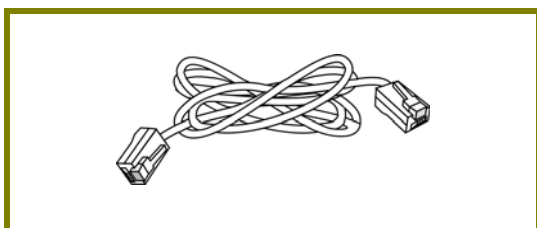

**RJ-45 Cable (Ethernet)**

The type of the power adapter depends on the country that the router will be installed. \* The maximum power consumption is *22 Watt*.

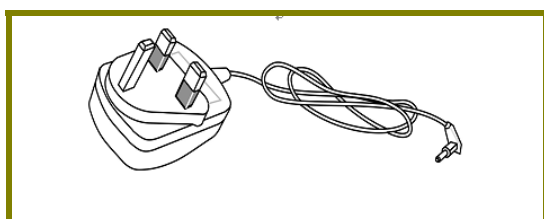

**UK-type Power Adapter**

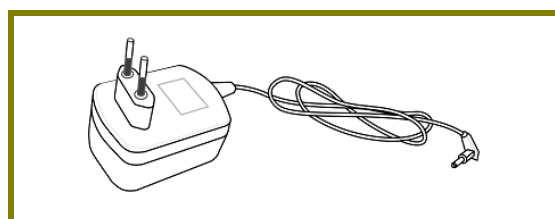

**EU-type Power Adapter**

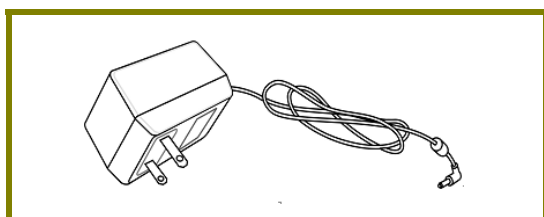

**USA/Taiwan-type Power Adapter**

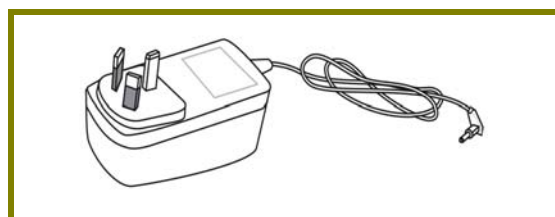

**AUNZ-type Power Adapter**

## 2. Panel Explanation

### 2.1 Vigor2927

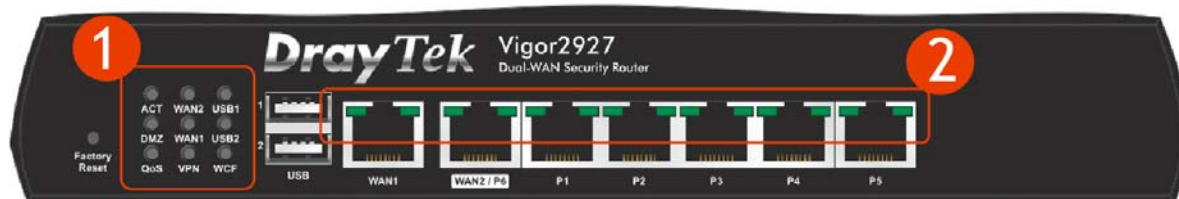

| No.       | LED             | Status  | Explanation                                    |
|-----------|-----------------|---|--|
| (1)       | ACT             | Off   | The router is powered off.                     |
|           |                 | Blinking  | The router is powered on and running normally. |
|           | WAN2/WAN1       | On  | Internet connection is ready.                  |
|           |                 | Off   | Internet connection is not ready.              |
|           |                 | Blinking  | The data is transmitting.                      |
|           | USB1/USB2       | On  | USB device is connected and ready for use.     |
|           |                 | Off   | No USB device is connected.                    |
|           |                 | Blinking  | The data is transmitting.                      |
|           | DMZ             | On  | The DMZ function is enabled.                   |
|           |                 | Off   | The DMZ function is disabled.                  |
|           |                 | Blinking  | The data is transmitting.                      |
|           | QoS             | On  | The QoS function is active.                    |
|           |                 | Off   | The QoS function is inactive.                  |
|           | VPN             | On  | The VPN tunnel is active.                      |
|           |                 | Off   | VPN services are disabled                      |
| Blinking  |                 | Traffic is passing through VPN tunnel.  |  |
| WCF       | On              | The Web Content Filter is active. (It is enabled from Firewall >> General Setup). |  |
|           | Off             | WCF is disabled.  |  |
| (2)       | WAN1, WAN2 / P6 |   |  |
|           | Left LED        | On  | The port is connected.                         |
|           |                 | Off   | The port is disconnected.                      |
|           |                 | Blinking  | The data is transmitting.                      |
|           | Right LED       | On  | The port is connected with 1000Mbps.           |
|           |                 | Off   | The port is connected with 10/100Mbps.         |
|           | LAN P1-P5       |   |  |
|           | Left LED        | On  | The port is connected.                         |
|           |                 | Off   | The port is disconnected.                      |
|           |                 | Blinking  | The data is transmitting.                      |
| Right LED | On              | The port is connected with 1000Mbps.  |  |
|           | Off             | The port is connected with 10/100Mbps   |  |





| No. | Interface     | Description   |
|-----|---------------|---|
| (3) | Factory Reset | Restore the default settings. Usage: Turn on the router (ACT LED is blinking). Press the hole and keep for more than 5 seconds. When you see the ACT LED begins to blink rapidly than usual, release the button. Then the router will restart with the factory default configuration. |
| (4) | USB           | Connector for a USB device (for 3G/4G USB Modem or printer or thermometer).   |
| (5) | WAN1          | Connector for local network devices or modem for accessing Internet.  |
|     | WAN2 / P6     | Connector for local network devices or modem for accessing Internet.<br>It is a switchable port. It can be used for LAN connection or WAN connection according to the settings configured in WUI.   |
|     | LAN P1-P5     | Connectors for local network devices.   |
| (6) | PWR           | Connector for a power adapter.  |
|     | ON/OFF        | Power Switch.   |

### 3. Hardware Installation

This section will guide you to install the router through hardware connection and configure the router's settings through web browser.

Before starting to configure the router, you have to connect your devices correctly.

#### 3.1 Network Connection

1. Connect the cable Modem/DSL Modem/Media Converter to any WAN port of router with Ethernet cable (RJ-45).
2. Connect one end of an Ethernet cable (RJ-45) to one of the LAN ports of the router and the other end of the cable (RJ-45) into the Ethernet port on your computer.
3. Connect one end of the power adapter to the router's power port on the rear panel, and the other side into a wall outlet.
4. Power on the device by pressing down the power switch on the rear panel.
5. The system starts to initiate. After completing the system test, the ACT LED will light up and start blinking. (For the detailed information of LED status, please refer to section 3. Panel Explanation)

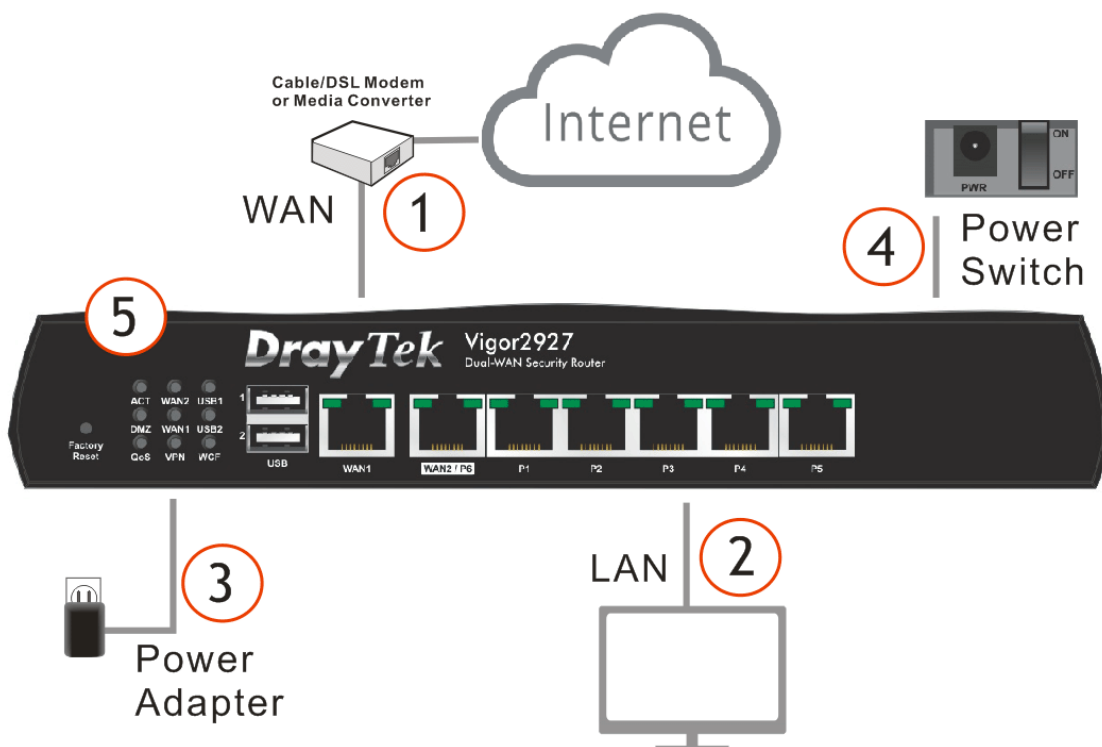

### 3.2 Wall-Mounted Installation

Vigor router has keyhole type mounting slots on the underside.

1. Drill two holes on the wall. The distance between the holes shall be 168mm.
2. Fit screws into the wall using the appropriate type of wall plug.

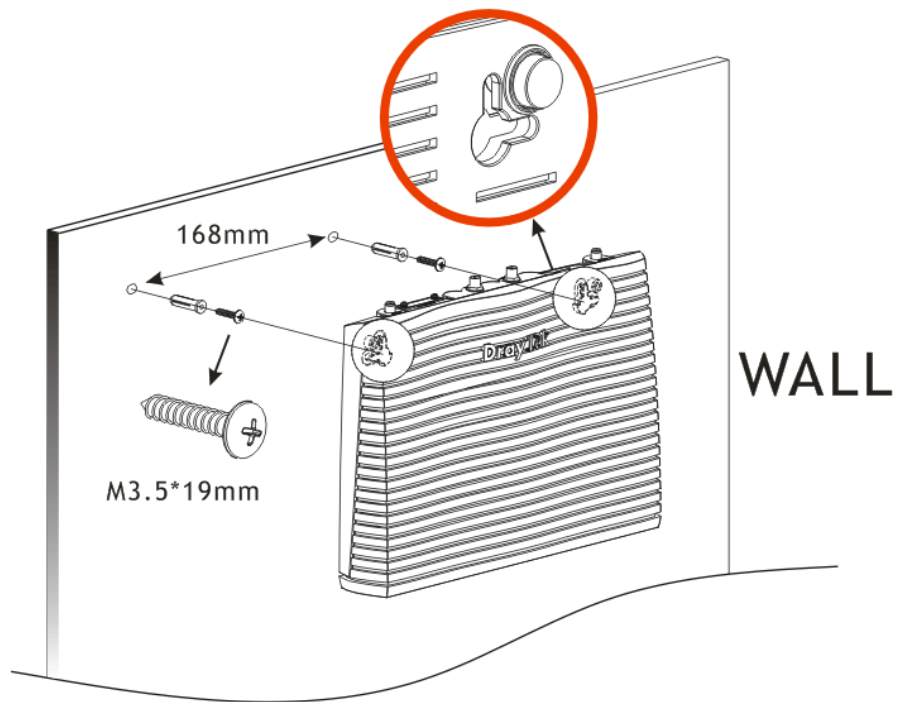

**Note**

The recommended drill diameter shall be 6.5mm (1/4").

3. When you finished about procedure, the router has been mounted on the wall firmly.

## 4. Software Configuration

To access Internet, please finish basic configuration after completing the hardware installation.

The **Quick Start Wizard** is designed for you to easily set up your router for Internet access. You can directly access the **Quick Start Wizard** via Web User Interface. Make sure your PC connects to the router correctly.



---

### Note

You may either simply set up your computer to get IP dynamically from the router or set up the IP address of the computer to be the same subnet as the default IP address of Vigor router 192.168.1.1. For the detailed information, please refer to - Trouble Shooting of the user's guide.

---

Open a web browser on your PC and type **http://192.168.1.1**. A pop-up window will open to ask for username and password. Please enter "admin/admin" as the Username/Password and click **Login**.

**DrayTek** **Vigor2927 Series**

**Login**

Username

Password

**Login**

**Security Warning: You are logging in without encryption which is not recommended. To login securely [click here](#).**

Copyright © 2000-2019 DrayTek Corp. All Rights Reserved.



---

### Note

If you fail to access to the web configuration, please go to "Trouble Shooting" on User's Guide for detecting and solving your problem.

---

Now, the Main Screen will pop up. Click Wizards>>Quick Start Wizard.

**DrayTek Vigor2927 Series**

**Dashboard**

Model Name: Vigor2927Lac | System Up Time: 0:16:49

Router Name: DrayTek | Current Time: Sat Jan 01 2000 00:16:21

Firmware Version: 4.2.0.2 | Build Date/Time: Jul 8 2020 11:52:59

LAN MAC Address: 14-49-BC-02-37-E8

| IPv4 LAN Information       |      |
|----------------------------|------|
| IP Address                 | DHCP |
| LAN1: 192.168.1.1/24       | v    |
| LAN2: 192.168.2.1/24       | v    |
| LAN3: 192.168.3.1/24       | v    |
| LAN4: 192.168.4.1/24       | v    |
| LAN5: 192.168.5.1/24       | v    |
| LAN6: 192.168.6.1/24       | v    |
| LAN7: 192.168.7.1/24       | v    |
| LAN8: 192.168.8.1/24       | v    |
| DMZ PORT: 192.168.254.1/24 | v    |
| IP Routed Subnet           | v    |

| IPv4 Internet Access             |              |                   |          |
|----------------------------------|--------------|-------------------|----------|
| Line / Mode                      | IP Address   | MAC Address       | Up Time  |
| WAN1 Ethernet / DHCP Client      | Disconnected | 14-49-BC-02-37-E9 | 00:00:00 |
| WAN2 Ethernet / DHCP Client      | Disconnected | 14-49-BC-02-37-EA | 00:00:00 |
| WAN3 Wireless 2.4G / DHCP Client | Disconnected | 12-59-BC-02-37-E8 | 00:00:00 |
| WAN4 Wireless 5G / ---           | Disconnected | 12-49-BC-02-37-E8 | 00:00:00 |
| LTE USB / ---                    | Disconnected | 00-A0-C6-00-00-55 | 00:00:00 |
| WAN6 USB / ---                   | Disconnected | 14-49-BC-02-37-EE | 00:00:00 |

| Interface   |              |
|-------------|--------------|
| Line / Mode | IP Address   |
| WAN         | Connected: 0 |
| LAN         | Connected: 0 |
| WLAN        | Connected: 0 |
| WLAN5G      | Connected: 0 |
| USB         | Connected: 0 |

| Security |                    |
|----------|--------------------|
| VPN      | Connected: 0       |
| MyVigor  | Activate: 0        |
| DoS      | Attack Detected: 0 |



**Note** The home page will change slightly in accordance with the router you have.

If your router can be under an environment with high speed NAT, the configuration provide here can help you to deploy and use the router quickly. The first screen of Quick Start Wizard is entering login password. After typing the password, please click Next.

**Quick Start Wizard**

**Enter login password**

Please enter an alpha-numeric string as your Password (Max 23 characters).

Old Password

New Password

Confirm Password

Hint: If you want to keep the password unchanged, leave the password blank and press "Next" button to skip this process.

< Back    Next >    Finish    Cancel

On the next page as shown below, please select the WAN interface that you use. If Ethernet interface is used, please choose WAN1 or WAN2; if wireless 2.4G/5G connection is used, please choose WAN3 or WAN4; if 3G USB modem is used, please choose WAN5 or WAN6. Then click **Next** for next step. Each WAN interface will bring up specific configuration page.

#### Quick Start Wizard

---

##### WAN Interface

|                    |                      |
|--------------------|----------------------|
| WAN Interface:     | WAN1 ▼               |
| Display Name:      | <input type="text"/> |
| Physical Mode:     | Ethernet             |
| Physical Type:     | Auto negotiation ▼   |
| VLAN Tag insertion | Disable ▼            |

Click **Next**. You have to select the appropriate Internet access type (PPPoE, PPTP, L2TP, Static IP or DHCP) according to the information from your ISP.

Here we take PPPoE and DHCP modes for WAN connection as examples.

## For PPPoE Connection

1. Choose WAN1 as WAN Interface and click the Next button; you will get the following page.

Quick Start Wizard

---

### Connect to Internet

**WAN 1**  
Select one of the following Internet Access types provided by your ISP.

- PPPoE
- PPTP
- L2TP
- Static IP
- DHCP

< Back   Next >   Finish   Cancel

2. Select PPPoE and click Next to get the following page.

Quick Start Wizard

---

### PPPoE Client Mode

**WAN 1**  
Enter the user name and password provided by your ISP.

|                         |   |
|-------------------------|---|
| Service Name (Optional) | <input type="text" value="CHTI"/>               |
| Username                | <input type="text" value="77554248@hinet.net"/> |
| Password                | <input type="password" value="*****"/>          |
| Confirm Password        | <input type="password" value="*****"/>          |

< Back   Next >   Finish   Cancel

3. Enter the Username/Password provided by your ISP. Then click **Next** for viewing the summary of such connection.

Quick Start Wizard

---

Please confirm your settings:

|                  |          |
|------------------|----------|
| WAN Interface:   | WAN1     |
| Physical Mode:   | Ethernet |
| Internet Access: | PPPoE    |

Click **Back** to modify changes if necessary. Otherwise, click **Finish** to save the current settings and restart the Vigor router.

4. Click **Finish**. A page of **Quick Start Wizard Setup OK!!!** will appear. Then, the system status of this protocol will be shown.
5. Now, you can enjoy surfing on the Internet.



## For DHCP Connection

1. Choose WAN1 as WAN Interface and click the Next button; you will get the following page.

Quick Start Wizard

---

### Connect to Internet

**WAN 1**  
Select one of the following Internet Access types provided by your ISP.

- PPPoE
- PPTP
- L2TP
- Static IP
- DHCP

2. Select DHCP and click Next to get the following page.

Quick Start Wizard

---

### DHCP Client Mode

**WAN 1**  
If your ISP requires you to enter a specific host name or specific MAC address, please enter it in.

Host Name  (optional)

MAC       (optional)

3. Enter the hostname and / or MAC address provided by your ISP. Then click **Next** for viewing summary of such connection.

#### Quick Start Wizard

---

Please confirm your settings:

|                  |          |
|------------------|----------|
| WAN Interface:   | WAN1     |
| Physical Mode:   | Ethernet |
| Internet Access: | DHCP     |

Click **Back** to modify changes if necessary. Otherwise, click **Finish** to save the current settings and restart the Vigor router.

4. Click **Finish**. A page of **Quick Start Wizard Setup OK!!!** will appear. Then, the system status of this protocol will be shown.

#### Quick Start Wizard Setup OK!

5. Now, you can enjoy surfing on the Internet.

## 5. Customer Service

If the router cannot work correctly after trying many efforts, please contact your dealer for further help right away. For any questions, please feel free to send e-mail to [support@draytek.com](mailto:support@draytek.com).

### Be a Registered Owner

Web registration is preferred. You can register your Vigor router via <http://www.draytek.com>.

### Firmware & Tools Updates

Due to the continuous evolution of DrayTek technology, all routers will be regularly upgraded. Please consult the DrayTek web site for more information on newest firmware, tools and documents.

<http://www.draytek.com>